



T755S

Pro1 Technologies, Inc.

1111 S. Glenstone Ave., Suite 2-100
Springfield, MO 65804

Toll-Free: 888-776-1427 Web: www.pro1iaq.com
Hours of Operation: M-F 9AM - 6PM Eastern

Thermostat Applications Guide

Description	
Gas or Oil Heat	Yes
Electric Furnace	Yes
Heat Pump (No Aux. or Emergency Heat)	Yes
Heat Pump (with Aux. or Emergency Heat)	Yes
Multi-stage Systems	Yes
Heat Only Systems	Yes
Cool Only Systems	Yes
Millivolt	Yes

Table of Contents

Page

Installation Tips	2
Thermostat Quick Reference	3
Subbase Installation	4
Wiring	5-6
Technician Setup Menu	7-11
Mounting and Battery Installation	12
Programming The Thermostat	13-14
Specifications	15

Power Type

Battery Power
Hardwire (Common Wire)
Hardwire (Common Wire) with Battery Backup

A trained, experienced technician must install this product.

Carefully read these instructions. You could damage this product or cause a hazardous condition if you fail to follow these instructions.

Una versión en español de este manual se puede descargar en la página web de la compañía.

Wall locations

The thermostat should be installed approximately 4 to 5 feet above the floor. Select an area with average temperature and good air circulation.

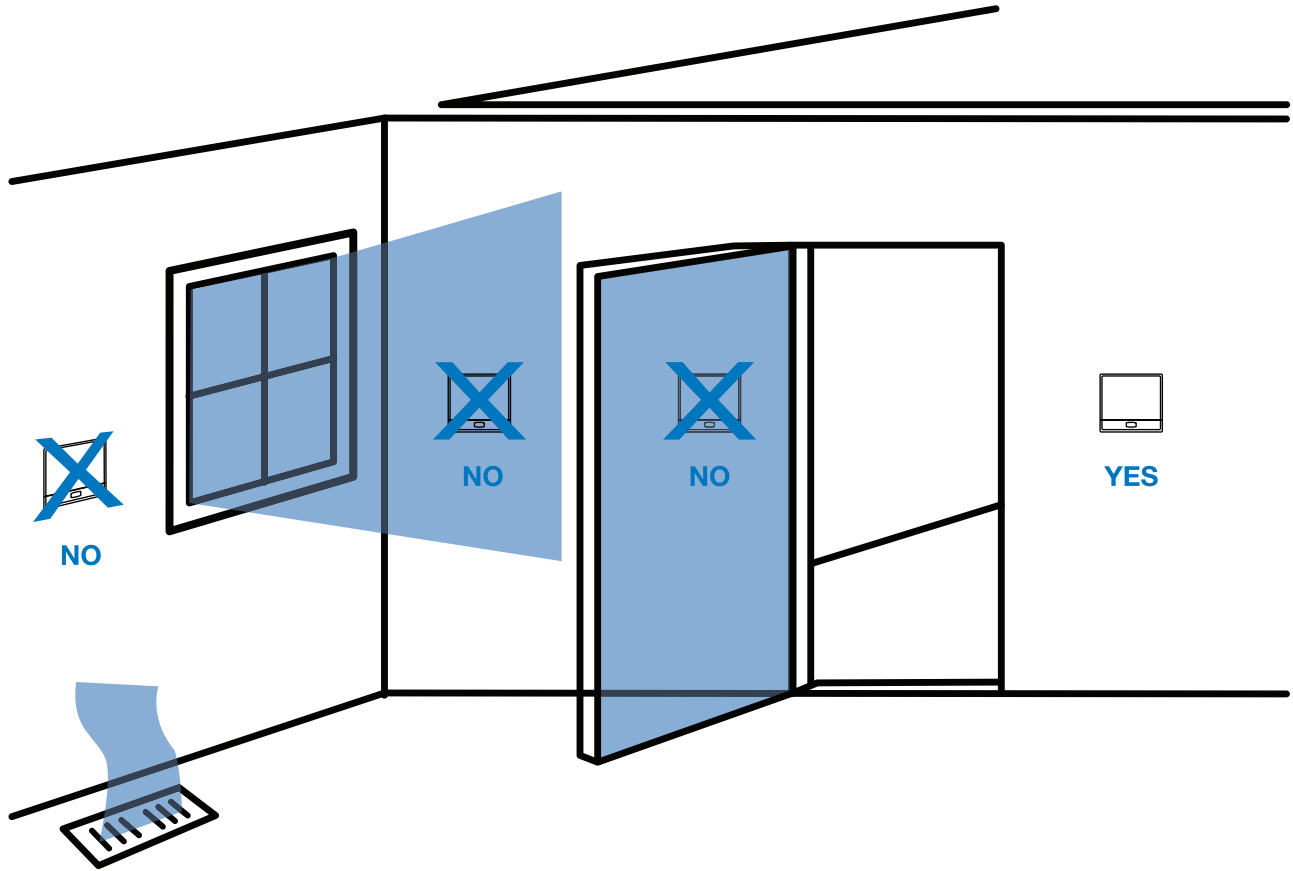

Do not install thermostat in locations:

- Close to hot or cold air ducts.
- That are in direct sunlight.
- With an outside wall behind the thermostat.
- In areas that do not require conditioning.
- Where there are dead spots or drafts (in corners or behind doors).
- Where there might be concealed chimneys or pipes.
- Where appliances could radiate heat.

PRO1 Tip

Pick an installation location that is easy for the user to access. The temperature of the location should be representative of the building.

Getting to know your thermostat

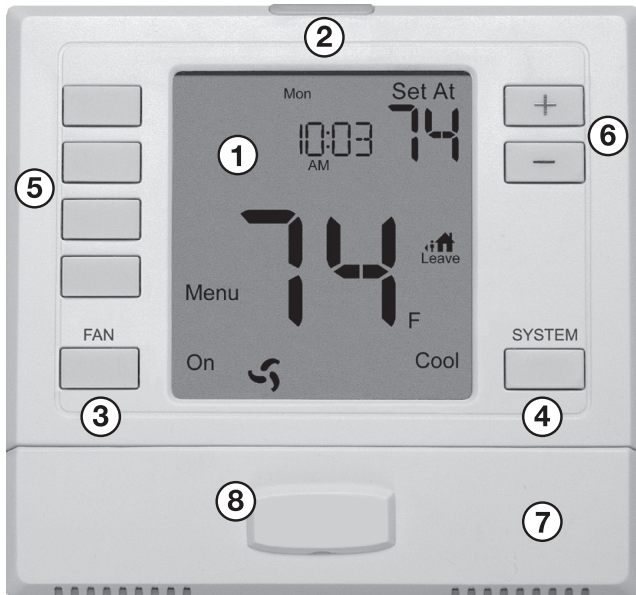

- ② Glow in the Dark Light Button
- ③ Fan Button
- ④ System Button
- ⑤ User Program Buttons
- ⑥ Temperature Setpoint Buttons
- ⑦ Battery Door
- ⑧ Universal Private Label Badge

① **LCD**

Days of the week, time, and outdoor temperature.

Displays the user selectable setpoint temperature.

HOLD is displayed when thermostat program is permanently overridden.

Low Battery Indicator: Replace batteries when this indicator is shown.

Programmable Time Period Icons: This thermostat has 4 programmable time periods per day.

System: Selects heat, off or cool as needed.

Menu Options: Shows different options.

+1 will appear in the display when second stage of heat or cool is on. +2 will appear for third stage of heat.

Indicates the current room temperature.

FAN HEAT COOL

The **FAN**, **HEAT**, or **COOL** icon will display when the **FAN**, **HEAT**, **COOL** is on. NOTE: The compressor delay feature is active if these icons are flashing. The compressor will not turn on until the 5 minute delay has elapsed. These may also flash for staging delay or floor sensor override.



Important:

The low battery indicator is displayed when the AA battery power is low. If the user fails to replace the battery within 21 days, the thermostat display will only show the low battery indicator as a final warning before the thermostat becomes inoperable. The batteries are located on the front of the thermostat.

Removing the private label badge



Use the bevel on lower ridge

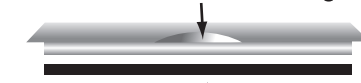

Magnet in door ↑

Gently slide a screwdriver into the bottom edge of the badge. Gently turn the screwdriver counter clockwise. The badge is held on by a magnet. The badge should pry off easily. **Do not use force.**

About The Badge

All Pro1 thermostats use the same universal magnetic badge. Visit our website at www.pro1iaq.com to learn more about our free private label program.



Caution:
Electrical Hazard

Failure to disconnect the power before beginning to install this product can cause electrical shock or equipment damage.



Mercury Notice:

All of Our products are mercury free. However, if the product you are replacing contains mercury, dispose of it properly. Your local waste management authority can give you instructions on recycling and proper disposal.

For vertical mount put one screw top and one screw bottom.

For horizontal mount put one screw left and one screw right.

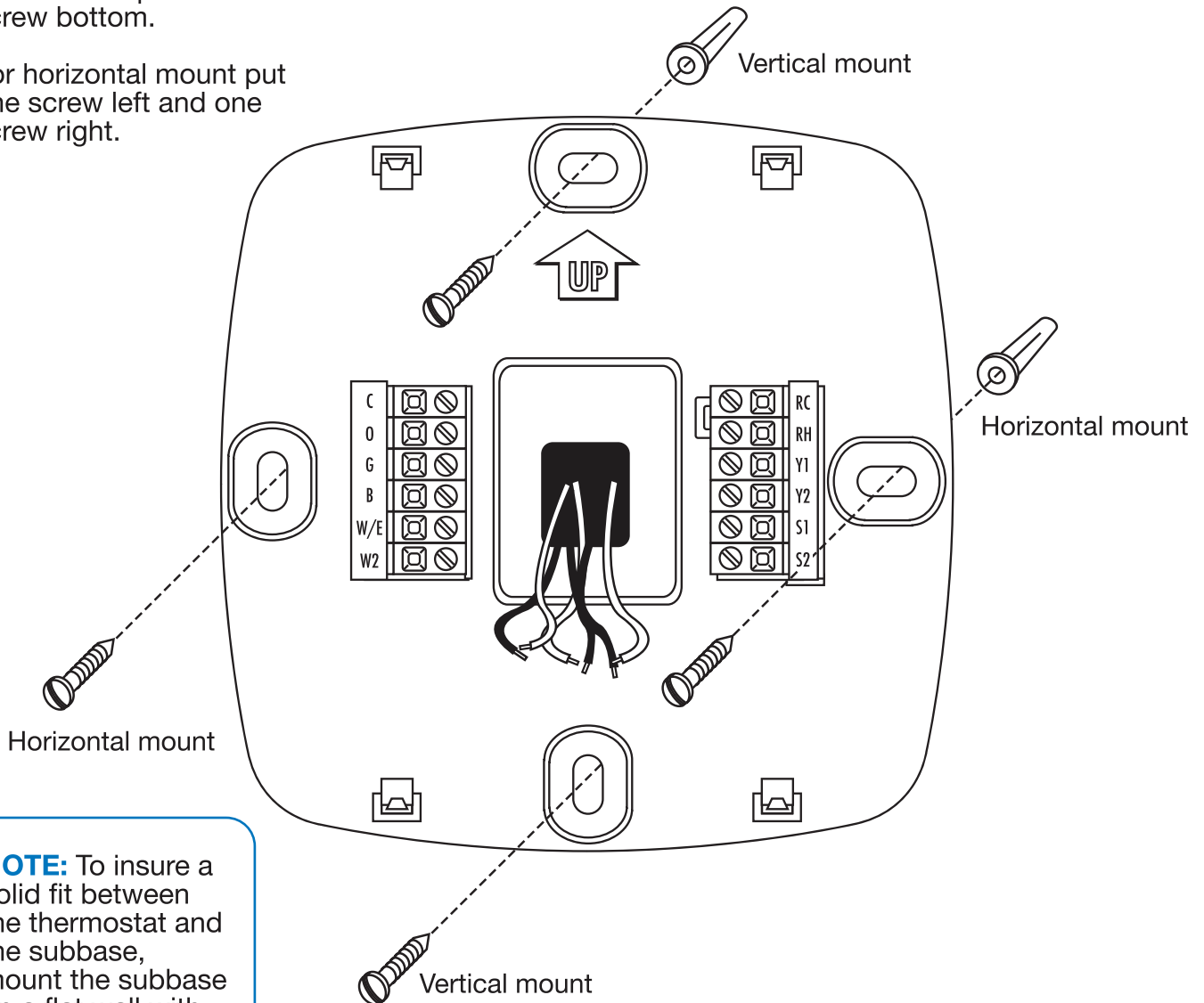

NOTE: To insure a solid fit between the thermostat and the subbase, mount the subbase on a flat wall with the drywall anchors flush to the wall.

Wiring

1. If you are replacing a thermostat, make note of the terminal connections on the thermostat that is being replaced. In some cases the wiring connections will not be color coded. For example, the green wire may not be connected to the **G** terminal.
2. Loosen the terminal block screws. Insert wires then retighten terminal block screws.
3. Place nonflammable insulation into wall opening to prevent drafts.
4. Push wire into the wall so the thermostat can mount securely to the subbase.



Warning:

All components of the control system and the thermostat installation must conform to Class II circuits per the NEC Code.

Wire specifications

Use shielded or non-shielded 18 - 22 gauge thermostat wire. Refer to the R251S install manual for connecting multiple indoor sensors.

Terminal Designations

This thermostat is shipped from the factory to operate a conventional heating and cooling system. This thermostat will also operate a heat pump system. See the “heat pump” configuration step on page 9 of this manual to configure the thermostat for heat pump applications.

Terminal	2 Heat 2 Cool Conventional System	2 Heat 2 Cool Heat Pump System	3 Heat 2 Cool Heat Pump System
RC	Transformer power (cooling)	Transformer power (cooling)	Transformer power (cooling)
RH	Transformer power (heating)	Transformer power (heating)	Transformer power (heating)
C	Transformer common (For 2 transformer systems, use RH common.)	Transformer common	Transformer common
B	Energized in heating	Heat pump changeover valve energized in heating	Heat pump changeover valve energized in heating
O	Energized in cooling	Heat pump changeover valve energized in cooling	Heat pump changeover valve energized in cooling
G	Fan relay	Fan relay	Fan relay
W/E	First stage of heat	First Stage of Emergency heat	First Stage of Emergency heat
Y	First stage of cool	First stage of heat & cool	First stage of heat & cool
Y2	Second stage of cool	Second stage of cool	Second stage of cool & second stage of heat
W2	Second stage of heat	Auxiliary heat relay, second stage of heat	Auxiliary heat relay, third stage of heat
S1/S2	Remote Sensor	Remote Sensor	Remote Sensor

PRO1 Tips:

C terminal

The **C** (common wire) terminal does not have to be connected when the thermostat is powered by batteries.

Note:

In many systems with no emergency heat relay a jumper can be installed between E and W2.

- ▲ 1 Power supply.
- ▲ 2 Factory-installed jumper. Remove only when installing on 2-transformer systems.
- ▲ 3 Use either O or B terminals for changeover valve.
- ▲ 4 Optional 24 VAC common connection when thermostat is used in battery power mode.

Typical 2H/2C system: 1 transformer

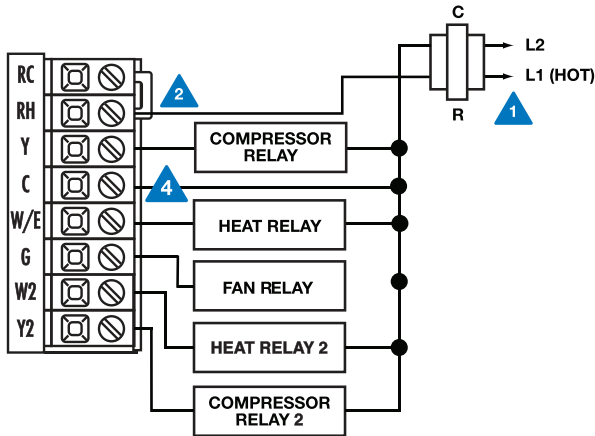

Typical 2H/2C system: 2 transformer

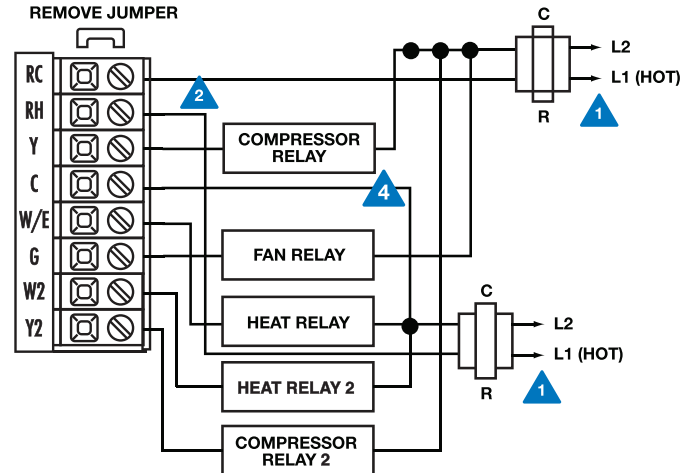

Typical 3H/2C heat pump system

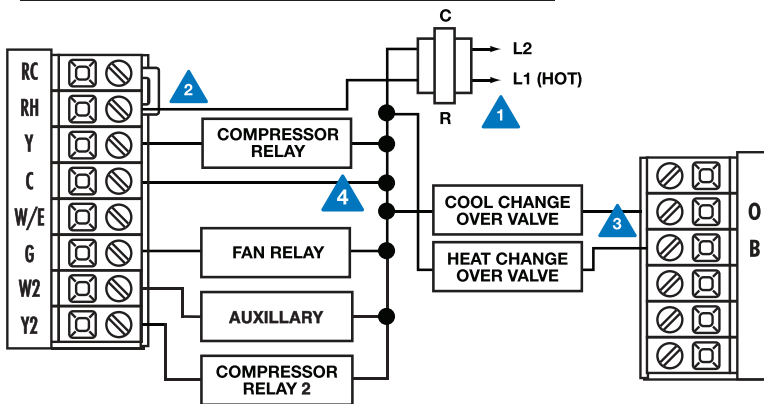

Typical heat-only system

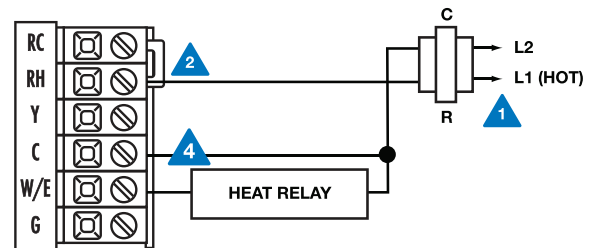

Typical heat-only system with fan

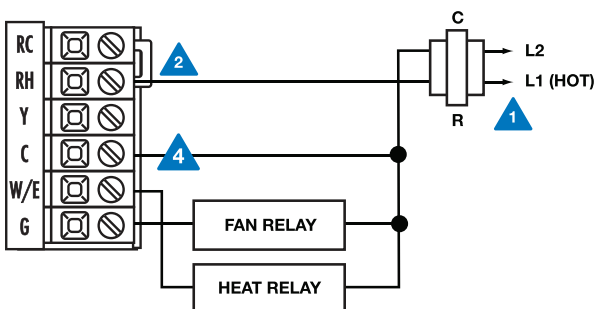

Typical cool-only system

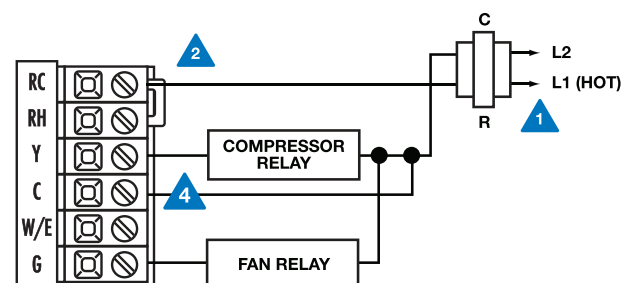

NOTE: In many systems with no emergency heat relay a jumper can be installed between E and W2.





Technician Setup Menu

This thermostat has a technician setup menu for easy installer configuration. To set up the thermostat for your particular application:

1. Press **MENU** button.
2. Press and hold **TECH SET** button for 3 seconds. This 3 second delay is designed so that homeowners do not accidentally access the installer settings.

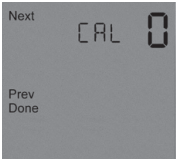
3. Configure the installer options as desired using the table below.

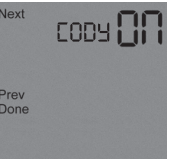
Use the **+** or **-** keys to change settings and the **NEXT STEP** or **PREV STEP** key to move from one step to another. **Note:** Only press **DONE** key when you want to exit the Technician Setup options.

Tech Setup Steps					
Filter Change Reminder	Room Temperature Calibration	Minimum Compressor On Time	Compressor Short Cycle Delay	Cooling Swing	Heating Swing
<p>This feature will flash FILT in the display after the elapsed run time to remind the user to change the filter. A setting of OFF will disable this feature.</p>	<p>This feature allows the installer to change the calibration of the room temperature display. For example, if the thermostat reads 70° and you would like it to read 72° then select +2.</p>	<p>This feature allows the installer to select the minimum run time for the compressor. For example, a setting of 4 will force the compressor to run for at least 4 minutes every time the compressor turns on, regardless of the room temperature.</p>	<p>The compressor short cycle delay protects the compressor from "short cycling". This feature will not allow the compressor to be turned on for 5 minutes after it was last turned off.</p>	<p>The swing setting, often called "cycle rate", "differential" or "anticipation" is adjustable. A smaller swing setting will cause more frequent cycles and a larger swing setting will cause fewer cycles.</p>	<p>The swing setting, often called "cycle rate", "differential" or "anticipation" is adjustable. A smaller swing setting will cause more frequent cycles and a larger swing setting will cause fewer cycles.</p>
LCD Will Show					
					
Adjustment Options					
<p>You can adjust the filter change reminder from OFF to 2000 hours of runtime in 50 hour increments.</p>	<p>You can adjust the room temperature display to ready -4°F to +4°F above or below the factory calibrated reading.</p>	<p>You can select the minimum compressor run time from "off", "3", "4", or "5" minutes. If 3, 4, or 5 is selected, the compressor will run for at least the selected time before turning off.</p>	<p>Selecting ON will not allow the compressor to be turned on for 5 minutes after the last time the compressor was on. Select OFF to remove this delay.</p>	<p>The cooling swing setting is adjustable from ±0.2°F to ±2°F. For example: A swing setting of 0.5°F will turn the cooling on at approximately 0.5°F above the setpoint and turn the cooling off at approximately 0.5°F below the setpoint.</p>	<p>The heating swing setting is adjustable from ±0.2°F to ±2°F. For example: A swing setting of 0.5°F will turn the heating on at approximately 0.5°F below the setpoint and turn the heating off at approximately 0.5°F above the setpoint.</p>
Factory Default Settings					
OFF	0 °F	OFF	ON	0.5 °F	0.4 °F

TECH SETUP
STEPS CONTINUED
ON THE NEXT PAGE



Tech Setup Steps (Continued from the previous page)

Morning Recovery	Heating Temperature Setpoint Limit	Cooling Temperature Setpoint Limit	°F or °C	12 or 24 Hour Clock	Fan Operation	Program Options
This feature will start heating early to bring the building temperature to its programmed setpoint by the beginning of the WAKE time period.	This feature allows you to set a maximum heat setpoint value. The setpoint temperature cannot be raised above this value.	This feature allows you to set a minimum cool setpoint value. The setpoint temperature cannot be lowered below this value.	Select F for Fahrenheit temperature read out or select C for Celsius read out.	You can select either a 12 or 24 hour clock setting.	Select GAS for systems that control the fan during a call for heat. Select ELEC to have the thermostat control the fan during a call for heat. Note: Not shown in Heat Pump Mode.	You can configure this thermostat to have a 5+1+1 program or non-programmable.
LCD Will Show						
Next: MORN ON Prev Done	Next: LIMIT 90 Prev Done: HE	Next: LIMIT 44 Prev Done: CO	Next: FORCE °F Prev Done	Next: CLOCK 12 Prev Done	Next: FAN GA Prev Done	Next: PROG 5d Prev Done
Adjustment Options						
Use the + or - key to turn on or off.	Use the + or - key to select the maximum heat setpoint.	Use the + or - key to select the minimum cool setpoint.	°F for Fahrenheit °C for Celsius	Use the + or - key to select 12 or 24 hour clock.	GA or EL	Use the + or - key 5d for 5+1+1, or 0d for non-programmable.
Factory Default Settings						
OFF	90	44	°F	12 Hour Clock	GAS	5d

TECH SETUP
STEPS CONTINUED
ON THE NEXT PAGE







Swing Setting Tip

The second stage will turn on at 2x the swing setting. The second stage will turn off when 1x the swing is reached. For example, if the swing setting is .5 degrees for heating and the thermostat is set at 70°F, the first stage will turn on at approximately 69.5°F. The second stage will turn on at 69.0°F. The second stage will turn off at 69.5°F and the first will turn off at 70.5°F.

NOTE:

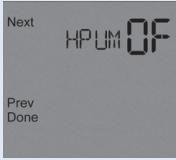
The optional staging delay feature will delay the stage for the amount selected. The optional satisfy setpoint feature will keep staging on until the setpoint is satisfied.

Tech Setup Steps (Continued from the previous page)

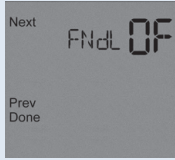
Heat Pump	System Switch	Gas Auxiliary for Heat Pump	Stages of Heat	Cooling Fan Delay
<p>When turned on the thermostat will operate a heat pump.</p> <p>1. EM.Heat will show as an option in the system switch.</p> <p>2. Y will be first stage of heat & cool, W/E will be emergency heat relay & W2 will be auxiliary heat relay.</p>	<p>You can configure the system switch for the particular application:</p> <p>Heat - Off - Cool Heat - Off Cool - Off</p> <p>Note: EM. Heat will show if in heat pump mode.</p>	<p>This option will turn the heat pump off 45 seconds after the auxiliary heat relay turns on.</p> <p>For 2 heat applications, the first stage will turn off 45 seconds after the auxiliary stage turns on.</p> <p>For 3 heat applications, the first and second stage will turn off 45 seconds after the auxiliary stage turns on.</p> <p>Note: Will only show if Heat Pump is set to on.</p>	<p>You can configure the thermostat to operate a 3 stage heat pump system.</p> <p>2H = 2 heat, 2 cool 3H = 3 heat, 2 cool</p> <p>Note: Will only show if Heat Pump is set to on.</p>	<p>The cooling fan delay setting will delay the fan from coming on in cool mode and keep running after the compressor shuts off for a short time to save energy in some systems.</p>
LCD Will Show				
				
Adjustment Options				
<p>OFF configures the thermostat for non heat pump systems.</p> <p>ON configures the thermostat for heat pump systems.</p>	<p>Use the + or - key until the desired application is flashing.</p>	<p>For heat pump systems that are "dual fuel" (use a gas furnace for auxiliary stage heat) you can turn this feature on to turn off the heat pump when the auxiliary stage of heating has been called for.</p>	<p>Use the + or - key to change between 2 heat and 3 heat.</p> <p>2 heat will use Y1 as first stage and W2 as auxiliary.</p> <p>3 heat will use Y1 as first stage, Y2 as second stage and W2 as auxiliary.</p>	<p>You can select the Cooling Fan Delay from "Off", "15", "30", "60" or "90" seconds. If 15, 30, 60, or 90 is selected the fan will not turn on for that many seconds when there is a call for cool and will run for that many seconds after satisfying a call for cool.</p>
Factory Default Settings				
OFF	Heat - Off - Cool	OFF	2 Stages	OFF

TECH SETUP
STEPS CONTINUED
ON THE NEXT PAGE



Note:

If used on a Heat Pump with an outdoor sensor and balance point, **Balance Point Run Time** can reduce call backs when the balance point is set slightly too low and heat pump can't keep up.

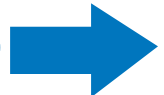

Tech Setup Steps (Continued)		Requires R251S	Requires R250S	Requires R250S	
Remote Sensor Operation	Local Temp Sensor	Number of Indoor Remotes	Balance Point (Gas Auxiliary On)	Balance Point (Gas Auxiliary Off)	Balance Run-Time
<p>You can configure the thermostat for one of three remote sensor applications:</p> <p>0 No Sensor 1 Indoor. 2 Outdoor. 3 Floor.</p>	<p>Disable the sensor on the T755S thermostat.</p> <p>At least one R251S indoor remote sensor must be connected to disable the local T755S sensor.</p> <p>Note: Will only show if Remote Sensor is set to 1.</p>	<p>Enables the use of up to sixteen indoor sensors R251S.</p> <p>Note: Will only show if Remote Sensor is set to 1 and Local Temp Sensor is set to on.</p>	<p>Balance point can eliminate the need for a fossil fuel kit. An outdoor temperature above balance point will cause the thermostat to only allow the Y terminal(s) to energize. An outdoor temperature below balance point will cause the thermostat to only allow W2 to energize.</p> <p>Note: Only shows up if Heat Pump is set to Yes and Remote Sensor is set to 2.</p>	<p>Balance point with electric auxiliary can optimize Heat Pump usage. An outdoor temperature above balance point will cause the thermostat to only allow the Y terminal(s) to energize. An outdoor temperature below balance point will cause the thermostat to allow the Y terminal(s) and the W2 terminal to energize.</p> <p>Note: Only shows up if Heat Pump is set to Yes and Remote Sensor is set to 2.</p>	<p>Balance point run time will allow the W2 auxiliary terminal to energize even if outdoor temperature is above the selected balance point temperature. If enabled, auxiliary will energize for the current cycle after the balance point run time has expired.</p> <p>Note: Only shows if Balance Point is set to an outdoor temperature.</p>
LCD Will Show					
Adjustment Options					
<p>Use the + or - key to select on of three options. View the S1/S2 terminal chart below for an explanation of these options.</p>	<p>ON enables local T755S sensor. OFF disables local T755S sensor.</p>	<p>1, 4, 9, 16 indoor sensors R251S connected. See R251S Install Manual for detailed connection information.</p>	<p>10, 20, 30, 35, 40, 45, 50 outdoor temperature balance point setting.</p> <p>NO</p>	<p>10, 20, 30, 35, 40, 45, 50 outdoor temperature balance point setting.</p> <p>NO</p>	<p>15, 30, 45, 60, 75, 90</p> <p>NO</p>
Factory Default Settings					
0	ON	1	NO	NO	NO

TECH SETUP STEPS CONTINUED ON THE NEXT PAGE



S1/S2 Terminal			
Options	Mode	Description	Requires
1	Indoor	The local and remote temperatures are averaged.	R251S
2	Outdoor	The outdoor temperature is flashed in clock.	R250S
3	Floor	The floor temperature is shown in tech.	R250S

Tech Setup Steps (Continued from the previous page)

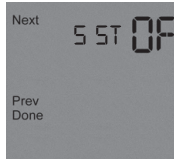
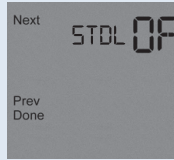
Floor Temperature	Floor High Limit	Floor Low Limit	Satisfy Setpoint	Staging Delay
<p>The temperature of the floor sensor will be displayed.</p> <p>Note: Only shows when REOP is set to 3.</p>	<p>This setting allows you to set a maximum floor temperature limit for heat.</p> <p>Heat will be locked out when the floor temperature is above this value.</p> <p>Note: Only shows when REOP is set to 3.</p>	<p>This setting allows you to set a minimum floor temperature limit for heat.</p> <p>Heat will turn on automatically when the floor temperature is below this value.</p> <p>Note: Only shows when REOP is set to 3.</p>	<p>This feature allows the thermostat to keep multiple stages of heat or cool energized until setpoint is satisfied.</p>	<p>This feature allows a delay to occur when a second and third stage is needed. This allows the previous stage extra time to satisfy setpoint.</p>
LCD Will Show				
				
Adjustment Options				
N/A	Use the + or - key to select the high limit for the floor sensor. 35-120	Use the + or - key to select the low limit for the floor sensor. 35-120	Use the + or - key to turn on or off.	Use the + or - key to select the number of minutes to delay each stage. OFF 5, 10, 15, 30, 45, 60, 90 delay minutes.
Factory Default Settings				
N/A	80	40	OFF	OFF

Note:

Standard staging logic, optional satisfy setpoint and optional staging delay allows for job by job customization that balances comfort, energy efficiency and equipment longevity.

MOUNT THERMOSTAT & BATTERY INSTALLATION

Mount Thermostat

Align the 4 tabs on the subbase with corresponding slots on the back of the thermostat, then push gently until the thermostat snaps in place.

Note: To insure a solid fit between the thermostat and the subbase:

1. Mount subbase to flat wall.
2. Use screws provided.
3. Drywall anchors should be flush with the wall.
4. Wires should be pushed into the wall.



Battery Installation

Battery installation is optional if thermostat is hardwired (C terminal connected).

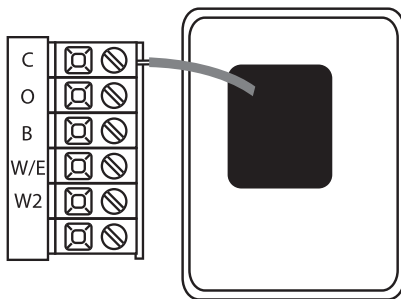

Insert 2 AA Alkaline batteries (included). High Quality Alkaline Batteries are recommended

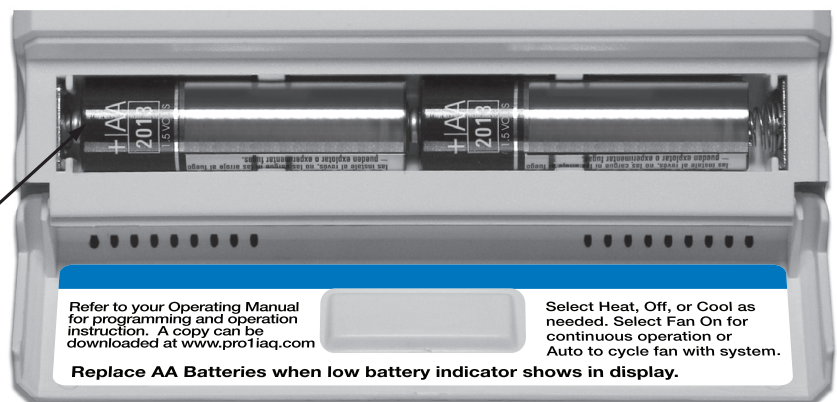

Simple operating instructions are found on the back of the battery door.

Set Time













Follow the steps below to set the day of the week and current time:

1. Press **MENU**.
2. Press **SET TIME**.
3. Day of the week will be flashing. Use the or key to select the current day of the week.
4. Press **NEXT STEP**.
5. The current hour is flashing. Use the or key to select the current hour. When using 12-hour time, make sure the correct a.m. or p.m. choice is selected.
6. Press **NEXT STEP**.
7. Minutes are now flashing. Use the or key to select current minutes.
8. Press **DONE** when completed.

Programming

All programmable Pro1 thermostats are shipped with an energy saving pre-program. You can customize this default program by following the Set Program Schedule.













Your thermostat can be programmed to have all the weekdays the same, a separate program for Saturday, and a separate program for Sunday. There are four time periods for each program (**WAKE, LEAVE, RETURN, SLEEP**).

Factory Default Program				
Day of the Week	Events	Time	Setpoint Temperature (Heat)	Setpoint Temperature (Cool)
Weekday	Wake 	6 a.m.	70° F (21° C)	75° F (24° C)
	Leave 	8 a.m.	62° F (17° C)	83° F (28° C)
	Return 	6 p.m.	70° F (21° C)	75° F (24° C)
	Sleep 	10 p.m.	62° F (17° C)	78° F (26° C)
Saturday	Wake 	8 a.m.	70° F (21° C)	75° F (24° C)
	Leave 	10 a.m.	62° F (17° C)	83° F (28° C)
	Return 	6 p.m.	70° F (21° C)	75° F (24° C)
	Sleep 	11 p.m.	62° F (17° C)	78° F (26° C)
Sunday	Wake 	8 a.m.	70° F (21° C)	75° F (24° C)
	Leave 	10 a.m.	62° F (17° C)	83° F (28° C)
	Return 	6 p.m.	70° F (21° C)	75° F (24° C)
	Sleep 	11 p.m.	62° F (17° C)	78° F (26° C)

INSTALLATION MANUAL

PROGRAMMING THE THERMOSTAT

You can use the table below to plan your customized program schedule if using 5+1+1.

Programming Table				
Day of the Week	Events	Time	Setpoint Temperature (Heat)	Setpoint Temperature (Cool)
Weekday	Wake 			
	Leave 			
	Return 			
	Sleep 			
Saturday	Wake 			
	Leave 			
	Return 			
	Sleep 			
Sunday	Wake 			
	Leave 			
	Return 			
	Sleep 			

Set Program Schedule

To customize your 5+1+1 program schedule, follow these steps

Weekday:

1. Select **HEAT** or **COOL** using the **SYSTEM** key.
Note: You have to program heat and cool each separately.
2. Press **MENU**.
3. Press **SET SCHED**. Note: Monday-Friday is displayed and the **WAKE** icon is shown. You are now programming the **WAKE** time period for the weekday setting.
4. Time is flashing. Use the or key to make your time selection for the weekday **WAKE** time period. Note: If you want the fan to run continuously during this time period, select **ON** with the **FAN** key.
5. Press **NEXT STEP**.
6. The setpoint temperature is flashing. Use the or key to make your setpoint selection for the weekday **WAKE** period.
7. Press **NEXT STEP**.
8. Repeat steps 4 through 7 for weekday **LEAVE** time period, for weekday **RETURN** time period, and for weekday **SLEEP** time period.

Saturday:

9. Repeat steps 4 through 7 for Saturday **WAKE** time period, for Saturday **LEAVE** time period, for Saturday **RETURN** time period, and for Saturday **SLEEP** time period.

Sunday:

10. Repeat steps 4 through 7 for Sunday **WAKE** time period, for Sunday **LEAVE** time period, for Sunday **RETURN** time period, and for Sunday **SLEEP** time period.

A Note About Programmable Fan:

The programmable fan feature will run the fan continuously during any time period it is programmed to be on. This is the best way to keep the air circulated and to eliminate hot & cold spots in your building.

Temporary and Permanent Hold Feature

Temporary hold: The thermostat will display **HOLD** and **RUN SCHED** on the left of your screen when you press the **+** or **-** key. If you do nothing, the temperature will remain at this setpoint temporarily for 4 hours. Your program setpoint will then replace your temporary setpoint.

Permanent hold: If you press **HOLD** key at the left of your screen, you will see **HOLD** appear below the setpoint temperature in the display. The thermostat will now permanently stay at this setpoint and can be adjusted using the **+** or **-** keys.

To return to program: Press the **RUN SCHED** key at the left of your screen to exit either temporary or permanent hold.

Notes:

When the R250S is used as an outdoor sensor and a dual fuel balance point is enabled, an outdoor temperature above balance point will cause the thermostat to only allow the Y terminal(s) to energize. An outdoor temperature below balance point will cause the thermostat to only allow the W2 to energize.

Notes:

The temperature shown is the average of all remotes, if remotes are used indoors.

Notes:

When using the R250S as a floor sensor, **High Limit** may cause system to be off even when temperature isn't yet satisfied. This is to avoid heating beyond setpoint.

Filter Change Reminder

If your installing contractor has configured the thermostat to remind you when the air filter needs changed, you will see **FILT** in the display when your air filter needs changed. **FILT** will be shown in the display after your system has run long enough to require an air filter change.

Resetting the filter change reminder: When **FILT** reminder is displayed, you should change your air filter and reset the reminder by holding down the second button from the top of the thermostat for 3 seconds.



Specifications

The display range of temperature	41°F to 95°F (5°C to 35°C)
The control range of temperature	44°F to 90°F (7°C to 32°C)
Load rating	1 amp per terminal, 1.5 amp maximum all terminals combined
Display accuracy	± 1°F
Swing (cycle rate or differential)	Heating is adjustable from 0.2°F to 2.0°F Cooling is adjustable from 0.2°F to 2.0°F
Power source	18 to 30 VAC, NEC Class II, 50/60 Hz for hardwire (common wire) Battery power from 2 AA Alkaline batteries
Operating ambient	32°F to +105°F (0° to +41°C)
Operating humidity	90% non-condensing maximum
Dimensions of thermostat	4.7"W x 4.4"H x 1.1"D