

PRO¹

T805

Pro1 Technologies, Inc.

1111 S. Glenstone Ave., Suite 2-100
Springfield, MO 65804

Toll-Free: 888-776-1427 **Web:** www.pro1iaq.com

Hours of Operation: M-F 9AM - 6PM Eastern



Thermostat Applications Guide

Description	
Gas or Oil Heat	Yes
Electric Furnace	Yes
Heat Pump (No Aux. or Emergency Heat)	Yes
Heat Pump (with Aux. or Emergency Heat)	No
Multi-stage Systems	No
Heat Only Systems	Yes
Cool Only Systems	Yes
Millivolt	Yes

Table of Contents

Page

Installation Tips	2
Thermostat Quick Reference	3
Subbase Installation	4
Wiring	5
Wiring Diagrams	6
Technician Setup Menu	7-9
Mounting and Battery Installation	10
Programming The Thermostat	11-13
Specifications	14

Power Type

Battery Power

Hardwire (Common Wire)

Hardwire (Common Wire) with Battery Backup

A trained, experienced technician must install this product.

Carefully read these instructions. You could damage this product or cause a hazardous condition if you fail to follow these instructions.

Una version espanola de este manual puede ser descargada en la pagina web de la compania.

Wall locations

The thermostat should be installed approximately 4 to 5 feet above the floor. Select an area with average temperature and good air circulation.

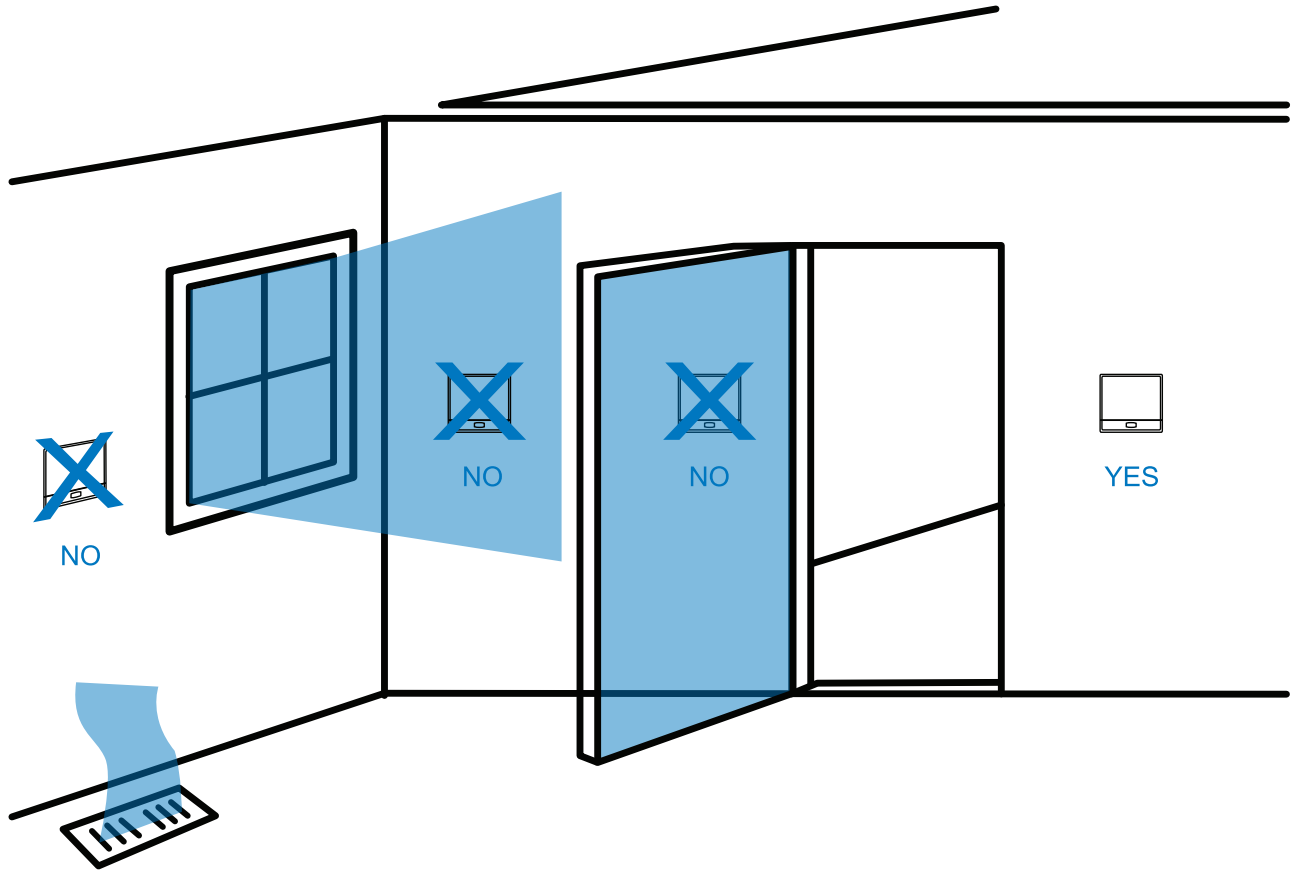

Do not install thermostat in locations:

- Close to hot or cold air ducts
- That are in direct sunlight
- With an outside wall behind the thermostat
- In areas that do not require conditioning
- Where there are dead spots or drafts (in corners or behind doors)
- Where there might be concealed chimneys or pipes

Installation Tip

Pick an installation location that is easy for the user to access. The temperature of the location should be representative of the building.

Getting to know your thermostat

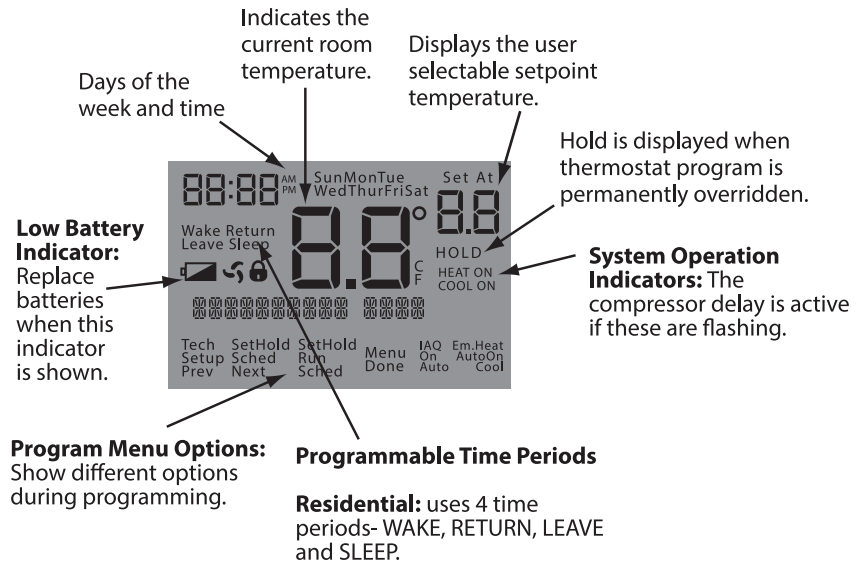

- ① LCD Display
- ② Glow in the Dark Light Button
- ③ Set Point Buttons
- ④-⑥ Program Buttons
- ⑦ Menu Button
- ⑧ Fan Button
- ⑨ System Button
- ⑩ Button/Battery Access Door
- ⑪ Battery Cover



Important

The low battery indicator is displayed when the AA battery power is low. If the user fails to replace the battery within 21 days, the screen will only show the low battery indicator but maintain all functionality. If the user fails to replace the batteries after an additional 21 days (days 22-42 since first "low battery" display) the set points will change to 55°F(Heating) and 85°F(Cooling). If the user adjusts these setpoints away from these it will hold for 4 hours then return to either 55°F or 85°F. After day 42 the batteries must be replaced immediately to avoid freezing or overheating because the thermostat will shut the unit off until the battery is changed.

Removing the private label badge



Use the bevel on lower ridge

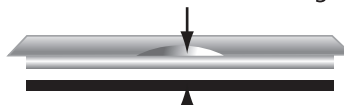

Magnet in door

Gently slide a screwdriver into the bottom edge of the badge. Gently turn the screwdriver counter clockwise. The badge is held on by a magnet. The badge should pry off easily. Do not use force.

About the Badge

All our thermostats use the same universal magnetic badge.
Visit our website to learn more about our free private label program.



Caution: Electrical Hazard

Failure to disconnect the power before beginning to install this product can cause electrical shock or equipment damage.



Mercury Notice:

All of our products are mercury free. However, if the product you are replacing contains mercury, dispose of it properly. Your local waste management authority can give you instructions on recycling and proper disposal.

For vertical mount put one screw top and one screw bottom.

For horizontal mount put one screw left and one screw right.

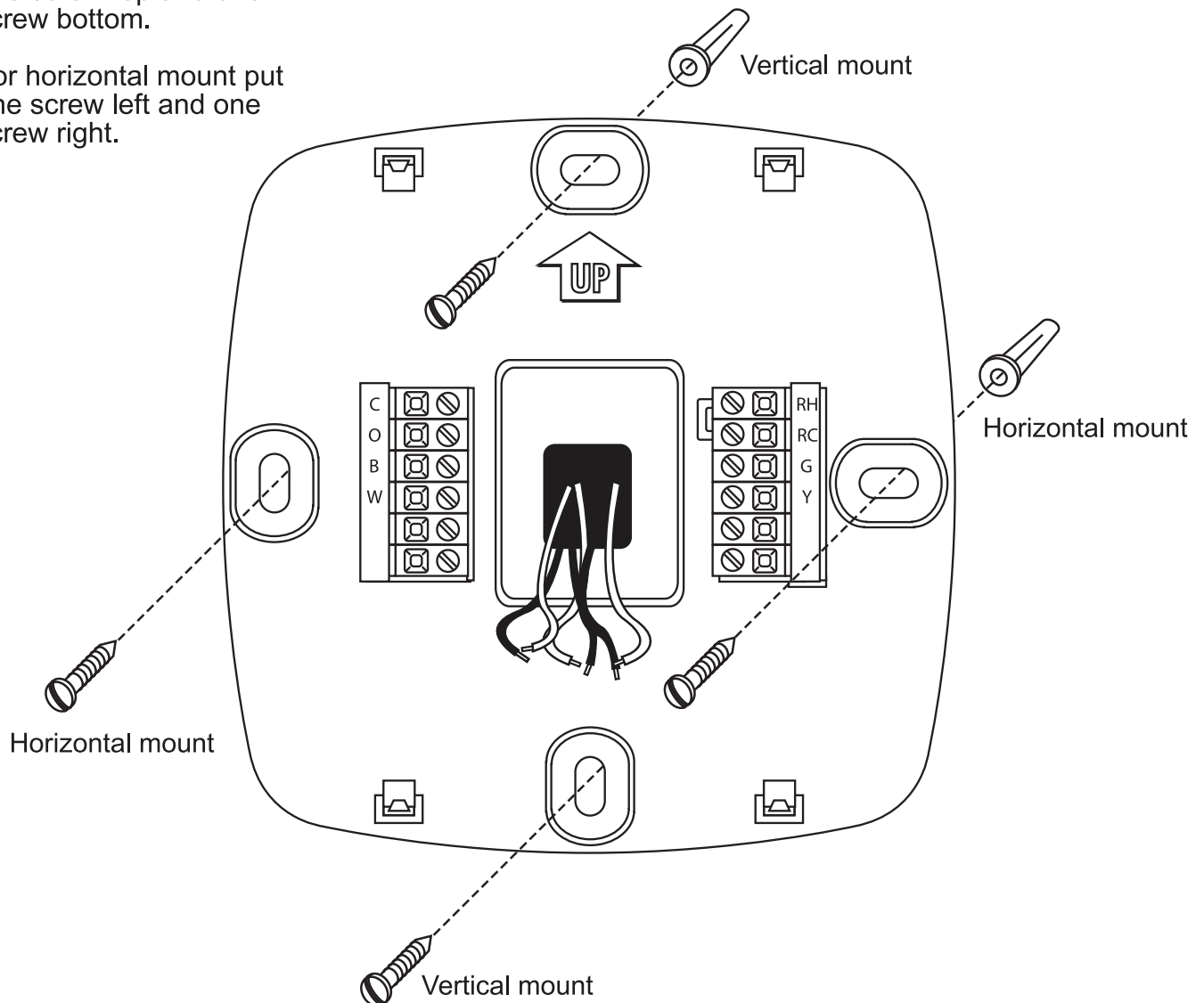



Caution: Electrical Hazard

Failure to disconnect the power before beginning to install this product can cause electrical shock or equipment damage.



Warning:

All components of the control system and the thermostat installation must conform to Class II circuits per the NEC Code.

Wiring

1. If you are replacing a thermostat, make note of the terminal connections on the thermostat that is being replaced. In some cases the wiring connections will not be color coded. For example, the green wire may not be connected to the G terminal.
2. Loosen the terminal block screws. Insert wires then retighten terminal block screws.
3. Place nonflammable insulation into wall opening to prevent drafts.



Caution:

Do not overtighten terminal block screws, as this can damage the terminal block. A damaged terminal block can keep the thermostat from fitting on the subbase correctly or cause system operation issues.

Max Torque = 6in-lbs

Terminal Designations

W Heat relay

Y Compressor relay

G Fan relay

O Heat pump changeover valve energized in cooling

RC Transformer power for cooling

RH Transformer power for heating

B Heat pump changeover valve energized in heating

C Common wire from secondary side of heating system transformer

PRO1 Tips:

RH & RC terminals

For single transformer systems, leave the jumper wire in place between RH and RC. Remove jumper wire for two transformer systems.

Heat pump systems

If wiring to a heat pump, use a small piece of wire (not supplied) to connect terminals W and Y.

C terminal

The C (common wire) terminal does not have to be connected when the thermostat is powered by batteries.

Wire specifications

Use shielded or non-shielded 18 - 22 gauge thermostat wire.

- ▲ 1 Power supply
- ▲ 2 Factory-installed jumper. Remove only when installing on 2-transformer systems.
- ▲ 3 Use either O or B terminals for changeover valve.
- ▲ 4 Use a small piece of wire (not supplied) to connect W and Y terminals.
- ▲ 5 Set fan operation switch to electric
- ▲ 6 Optional 24 VAC common connection when thermostat is used in battery power mode.

Typical 1H/1C system: 1 transformer

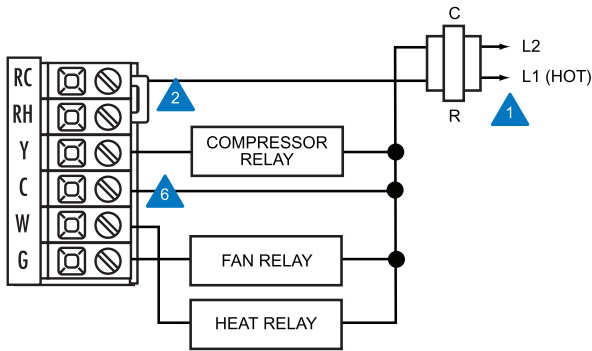

Typical 1H/1C system: 2 transformer

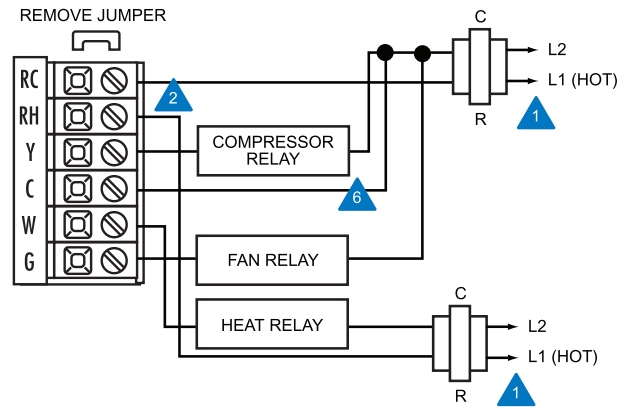

Typical 1H/1C heat pump system ▲ 5

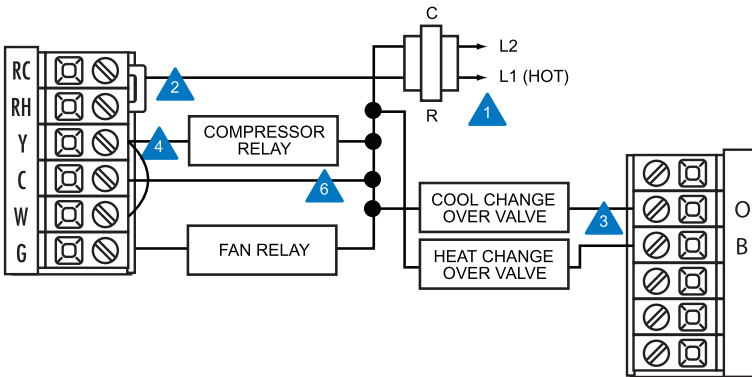

Typical heat-only system

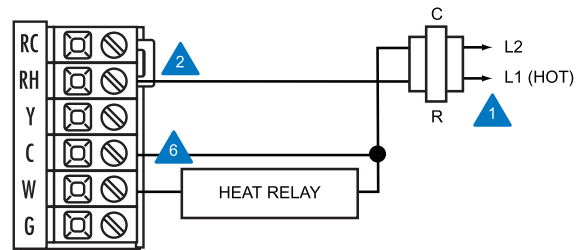

Typical heat-only system with fan

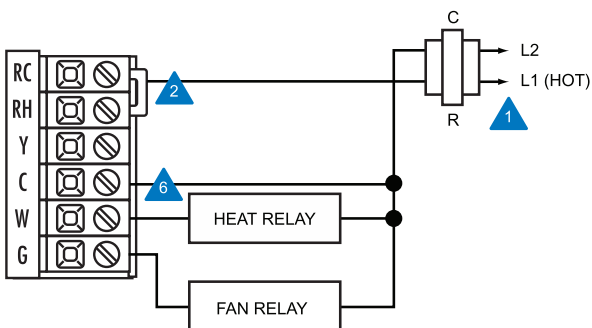

Typical cool-only system

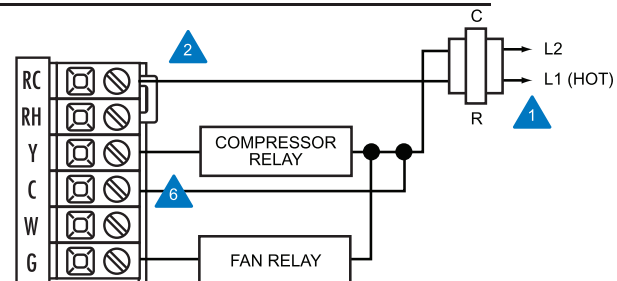







Technician Setup Menu

This thermostat has a technician setup menu for easy installer configuration. To set up the thermostat for your particular application:

1. Press MENU button
2. Press and hold TECHNICIAN SETUP button for 3 seconds. This 3 second delay is designed so that homeowners do not accidentally access the installer settings.

3. Configure the installer options as desired using the table below.

Use the **+** or **-** keys to change settings and the NEXT STEP or PREV STEP key to move from one step to another. Note: Only press DONE key when you want to exit the Technician Setup options.







Tech Setup Steps						
Filter Change Reminder	Room Temperature Calibration	Minimum Compressor On Time	Compressor Short Cycle Delay	Cooling Swing	Heating Swing	Keypad Lockout
This feature will flash FILT in the display after the elapsed run time to remind the user to change the filter. A setting of OFF will disable this feature.	This feature allows the installer to change the calibration of the room temperature display. For example, if the thermostat reads 70° and you would like it to read 72° then select +2.	This feature allows the installer to select the minimum run time for the compressor. For example, a setting of 4 will force the compressor to run for at least 4 minutes every time the compressor turns on, regardless of the room temperature.	The compressor short cycle delay protects the compressor from "short cycling". This feature will not allow the compressor to be turned on for 5 minutes after it was last turned off.	The swing setting, often called "cycle rate", "differential" or "anticipation" is adjustable. A smaller swing setting will cause more frequent cycles and a larger swing setting will cause fewer cycles.	The swing setting, often called "cycle rate", "differential" or "anticipation" is adjustable. A smaller swing setting will cause more frequent cycles and a larger swing setting will cause fewer cycles.	Keypad lockout allows you to configure the thermostat so that none or some of the keys do not function.
LCD Will Show						
						
Adjustment Options						
You can adjust the filter change reminder from OFF to 2000 hours of runtime in 50 hour increments.	You can adjust the room temperature display to read -4°F to +4°F above or below the factory calibrated reading.	You can select the minimum compressor run time from "off", "3", "4", or "5" minutes. If 3, 4, or 5 is selected, the compressor will run for at least the selected time before turning off.	Selecting ON will not allow the compressor to be turned on for 5 minutes after the last time the compressor was on. Select OFF to remove this delay.	The cooling swing setting is adjustable from ±0.2°F to ±2°F. For example: A swing setting of 0.5°F will turn the cooling on at approximately 0.5°F above the setpoint and turn the cooling off at approximately 0.5°F below the setpoint.	The heating swing setting is adjustable from ±0.2°F to ±2°F. For example: A swing setting of 0.5°F will turn the heating on at approximately 0.5°F below the setpoint and turn the heating off at approximately 0.5°F above the setpoint.	PA = partial keypad lockout, which locks all the keys except the + or - keys. FU = Full keypad lockout, which locks out all the keys. Note: keypad lockout instructions are below.
Factory Default Settings						
OFF	0°F	OFF	ON	0.5°F	0.4°F	OFF

Note: The function of activating your Keypad Lockout choice takes place after you have exited Tech Setup. If you do not perform this activation procedure, all keys will function freely. To lock the keypad hold down the **+** and **-** keys for 3 seconds. You will see a lock in the display. To unlock the keypad hold down the **+** and **-** keys for 3 seconds.

TECH SETUP
STEPS CONTINUED
ON THE NEXT PAGE



Tech Setup Steps (Continued from the previous page)

Heating Temperature Setpoint Limit	Cooling Temperature Setpoint Limit	°F or °C	12 or 24 Hour Clock	Fan Operation	Morning Recovery	Program Options
This feature allows you to set a maximum heat setpoint value. The setpoint temperature cannot be raised above this value.	This feature allows you to set a minimum cool setpoint value. The setpoint temperature cannot be lowered below this value.	Select F for Fahrenheit temperature read out or select C for Celsius read out	You can select either a 12 or 24 hour clock setting.	Select GAS for systems that control the fan during a call for heat. Select ELEC to generate the fan when the fan relay is connected to the G terminal.	This feature will start heating early to bring the building temperature to its programmed setpoint by the beginning of the time period (WAKE, OCCUPIED).	You can configure this thermostat to have a 7 day program, a 5+1+1 program or nonprogrammable.
LCD Will Show						
						
Adjustment Options						
Use the + or - key to select the maximum heat setpoint.	Use the + or - key to select the minimum cool setpoint.	°F for Fahrenheit °C for Celsius	Use the + or - key to select 12 or 24 hour clock.	GAS or ELEC	Use the + or - key to turn on or off.	Use the + or - key to select 7d for 7 day, 5d for 5+1+1, or 0d for nonprogrammable.
Factory Default Settings						
90 °F	44 °F	°F	12 Hour Clock	GAS	ON	5d







TECH SETUP
STEPS CONTINUED
ON THE NEXT PAGE



Saving Setting Tip

Temperature swing, sometimes called differential or cycle rate, can be customized for this individual application. For most applications choose a swing setting that is as long as possible without making the occupants uncomfortable.

Tech Setup Steps (Continued from the previous page)

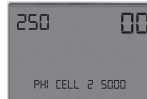
Display Light	Contractor Call Number	Beep	System Switch	Cooling Fan Delay	Humidity Pad Reminder	UV Lamp Reminder	IAQ Cell Reminder
The display light can be configured to come on when any key is pressed or only when the light key is pressed.	Allows you to put your phone number in the display. You can choose ON or OFF	When any key is pressed an audible beep will sound. There is an ON or an OFF.	You can configure the system switch for the particular application: Heat - Off - Cool, Heat - Off, Cool - Off, Heat - Off - Cool - Auto	The cooling fan delay setting will delay the fan from coming on in cool mode and keep running after the compressor shuts off for a short time to save energy in some systems.	This will remind the user to change the humidity pad.	Will remind the user to change the UV light bulb.	Will remind the user to change the PHI Cell after 25,000 hrs.
LCD Will Show							
							
Adjustment Options							
OFF configures display light to come on only with the light key, which will save battery power. ON configures the display light to come on when any key is pressed.	If selected ON, you will see the input screen after pressing next step. Use the + or - keys to select the desired number and the FAN or SYSTEM key to move from one character to another. See Note below on operation.	If ON is selected the beep will sound. If OFF is selected, there is no sound.	Use the + or - key to select the desired application.	You can select the Cooling Fan Delay from OFF, 15, 30, 60 or 90 Seconds.	Use the + or - key to select OFF, 600, 1000, 1500, 2000. These represent hours of heat operation.	Use the + or - key to select OFF, 1YEAR, 2YEAR.	Use the + or - key to select OFF, 250. (Stands for 25000 hours)
Factory Default Settings							
ON	OFF	ON	Heat - Off - Cool	OFF	OFF	OFF	OFF

Reminders Note: Once a Reminder has been turned on and set, the elapsed time can be checked by navigating to it's tech setup step. The elapsed time will then appear in the text field. It can also be reset at that time by a press and hold of the third button from the left for 3 seconds. Resetting an expired Reminder can be done without entering tech setup, by a press and hold of the 3rd button from the left for 3 seconds.

Note: If contractor Call Number is selected ON, your phone number will show in the display if there has been a continuous call for heating or cooling for 24 hours or if the light button is held down for 3 seconds. To remove the phone number from the display, hold the light button down for 3 seconds.

INSTALLATION MANUAL

MOUNT THERMOSTAT & BATTERY INSTALLATION

Mount Thermostat

Align the 4 tabs on the subbase with corresponding slots on the back of the thermostat, then push gently until the thermostat snaps in place.

Note: To insure a solid fit between the thermostat and the subbase:

1. Mount subbase to a flat wall
2. Use screws provided
3. Drywall anchors should be flush with the wall
4. Wires should be pushed into the wall



Battery Installation

Battery installation is recommended even if thermostat is hardwired (C terminal connected). When thermostat is hardwired and batteries are installed, the thermostat will activate a compressor delay of 5 minutes when the thermostat detects a power outage from the hardwired power supply.

Important:

High quality alkaline batteries are recommended. Rechargeable batteries or low quality batteries do not guarantee a 1-year life span.

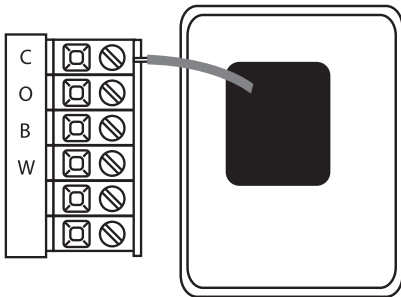

To release battery cover press finger bevel on the left side and lift the cover to access batteries.

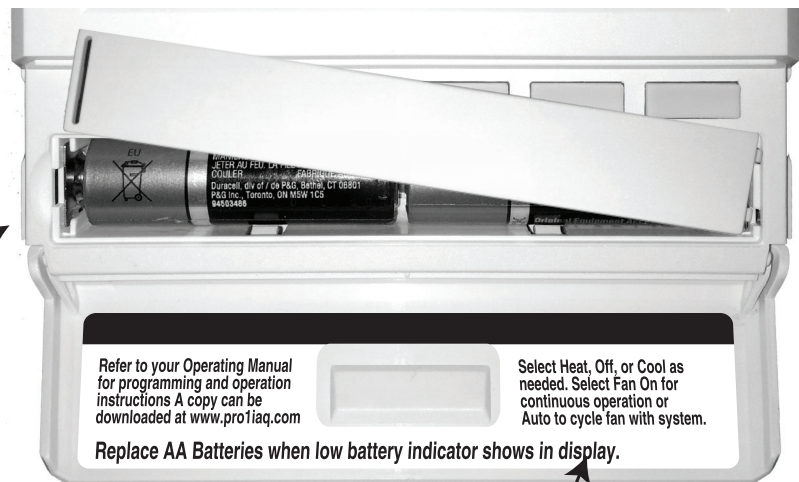

Simple operating instructions are found on the back of the battery door.

Set Time













Follow the steps below to set the day of the week and current time:

1. Press MENU
2. Press SET TIME
3. Day of the week will be flashing. Use the or key to select the current day of the week.
4. Press NEXT
5. The current hour is flashing. Use the or key to select the current hour. When using 12-hour time, make sure the correct a.m. or p.m. choice is selected.
6. Press NEXT
7. Minutes are now flashing. Use the or key to select current minutes
8. Press DONE when completed

Programming

All programmable thermostats are shipped with an energy saving pre-program. You can customize this default program by following the Set Program Schedule.













Your thermostat can be programmed to have each day of the week programmed uniquely (7 days), all the weekdays the same, a separate program for Saturday, and a separate program for Sunday (5+1+1), or non-programmable. This thermostat has a programmable fan feature, which allows you to run the fan continuously during any time period. There are four time periods for each program (WAKE, LEAVE, RETURN, SLEEP).

Factory Default Program				
Day of the Week	Events	Time	Setpoint Temperature (Heat)	Setpoint Temperature (Cool)
Weekday	Wake 	6 a.m.	70° F (21° C)	75° F (24° C)
	Leave 	8 a.m.	62° F (17° C)	83° F (28° C)
	Return 	6 p.m.	70° F (21° C)	75° F (24° C)
	Sleep 	10 p.m.	62° F (17° C)	78° F (26° C)
Saturday	Wake 	8 a.m.	70° F (21° C)	75° F (24° C)
	Leave 	10 a.m.	62° F (17° C)	83° F (28° C)
	Return 	6 p.m.	70° F (21° C)	75° F (24° C)
	Sleep 	11 p.m.	62° F (17° C)	78° F (26° C)
Sunday	Wake 	8 a.m.	70° F (21° C)	75° F (24° C)
	Leave 	10 a.m.	62° F (17° C)	83° F (28° C)
	Return 	6 p.m.	70° F (21° C)	75° F (24° C)
	Sleep 	11 p.m.	62° F (17° C)	78° F (26° C)

INSTALLATION MANUAL

PROGRAMMING THE THERMOSTAT

You can use the table below to plan your customized program schedule if using 5+1+1.

Programming Table				
Day of the Week	Events	Time	Setpoint Temperature (Heat)	Setpoint Temperature (Cool)
Weekday	Wake 			
	Leave 			
	Return 			
	Sleep 			
Saturday	Wake 			
	Leave 			
	Return 			
	Sleep 			
Sunday	Wake 			
	Leave 			
	Return 			
	Sleep 			

Set Program Schedule

To customize your 5+1+1 program schedule, follow these steps

Weekday:

1. Select HEAT or COOL using the SYSTEM key.
Note: You have to program heat and cool each separately.
2. Press MENU
3. Press SET SCHED. Note: Monday-Friday is displayed and the WAKE icon is shown. You are now programming the WAKE time period for the weekday setting.
4. Time is flashing. Use the or key to make your time selection for the weekday WAKE time period. Note: If you want the fan to run continuously during this time period, select ON with the FAN key.
5. Press NEXT
6. The setpoint temperature is flashing. Use the or key to make your setpoint selection for the weekday WAKE period.
7. Press NEXT
8. Repeat steps 4 through 7 for weekday LEAVE time period, for weekday RETURN time period, and for weekday SLEEP time period.

Saturday:

9. Repeat steps 4 through 7 for Saturday WAKE time period, for Saturday LEAVE time period, for Saturday RETURN time period, and for Saturday SLEEP time period.

Sunday:

10. Repeat steps 4 through 7 for Sunday WAKE time period, for Sunday LEAVE time period, for Sunday RETURN time period, and for Sunday SLEEP time period.

To customize your 7 day program schedule, follow these steps:

1. Select HEAT or COOL using the system key. You have to program heat and cool each separately.
2. Press MENU
3. Press SET SCHED
Note: Monday is displayed and the WAKE icon is shown. You are now programming the WAKE time period for the Monday setting.
4. Time is flashing. Use the or key to make your time selection for the Monday WAKE time period. Note: If you want the fan to run continuously during this time period, select ON with the FAN key.
5. Press NEXT
6. The setpoint temperature is flashing. Use the or key to make your setpoint selection for the Monday WAKE period.
7. Press NEXT
8. Repeat steps 4 thru 7 for Monday LEAVE time period, for Monday RETURN time period, and for Monday SLEEP time period.

Tuesday, Wednesday, Thursday, Friday, Saturday, Sunday

Repeat steps 4 thru 7 for the remaining days of the week.

A Note About Auto Changeover:

If in Auto you have the ability to switch between Auto Heat or Auto Cool by pressing the System key. This can be done once the current mode has reached its set-point. For example: if in Auto Heat, the heat setpoint must be satisfied before the thermostat will allow you to switch to Auto Cool. You can switch out of Auto by holding down the System key. To get back into Auto, you must toggle the System key to Auto.

A Note About Programmable Fan:

The programmable fan feature will run the fan continuously during any time period it is programmed to be on. This is the best way to keep the air circulated and to eliminate hot & cold spots in your building.

Specifications

The display range of temperature	41°F to 95°F (5°C to 35°C)
The control range of temperature	44°F to 90°F (7°C to 32°C)
Load rating	1 amp per terminal, 1.5 amp maximum all terminals combined
Display accuracy	± 1°F
Swing (cycle rate or differential)	Heating is adjustable from 0.2°F to 2.0°F Cooling is adjustable from 0.2°F to 2.0°F
Power source	18 to 30 VAC, NEC Class II, 50/60 Hz for hardwire (common wire) Battery power from 2 AA Alkaline Energizer batteries
Operating ambient	32°F to +105°F (0° to +41°C)
Operating humidity	90% non-condensing maximum
Dimensions of thermostat	4.7"W x 4.4"H x 1.1"D